

रोल नं.

--	--	--	--	--	--	--

Roll No.

परीक्षार्थी कोड को उत्तर-पुस्तिका के मुख-पृष्ठ पर अवश्य लिखें ।

Candidates must write the Code on the title page of the answer-book.

- कृपया जाँच कर लें कि इस प्रश्न-पत्र में मुद्रित पृष्ठ 16 हैं ।
- प्रश्न-पत्र में दाहिने हाथ की ओर दिए गए कोड नम्बर को छात्र उत्तर-पुस्तिका के मुख-पृष्ठ पर लिखें ।
- कृपया जाँच कर लें कि इस प्रश्न-पत्र में 26 प्रश्न हैं ।
- कृपया प्रश्न का उत्तर लिखना शुरू करने से पहले, प्रश्न का क्रमांक अवश्य लिखें ।
- इस प्रश्न-पत्र को पढ़ने के लिए 15 मिनट का समय दिया गया है । प्रश्न-पत्र का वितरण पूर्वाह्न में 10.15 बजे किया जाएगा । 10.15 बजे से 10.30 बजे तक छात्र केवल प्रश्न-पत्र को पढ़ेंगे और इस अवधि के दौरान वे उत्तर-पुस्तिका पर कोई उत्तर नहीं लिखेंगे ।
- Please check that this question paper contains 16 printed pages.
- Code number given on the right hand side of the question paper should be written on the title page of the answer-book by the candidate.
- Please check that this question paper contains 26 questions.
- **Please write down the Serial Number of the question before attempting it.**
- 15 minute time has been allotted to read this question paper. The question paper will be distributed at 10.15 a.m. From 10.15 a.m. to 10.30 a.m., the students will read the question paper only and will not write any answer on the answer-book during this period.

भौतिक विज्ञान (सैद्धान्तिक)

PHYSICS (Theory)

निर्धारित समय : 3 घण्टे

Time allowed : 3 hours

अधिकतम अंक : 70

Maximum Marks : 70



सामान्य निर्देश :

- (i) सभी प्रश्न अनिवार्य हैं। इस प्रश्न-पत्र में कुल 26 प्रश्न हैं।
- (ii) इस प्रश्न-पत्र के 5 भाग हैं : खण्ड अ, खण्ड ब, खण्ड स, खण्ड द और खण्ड य।
- (iii) खण्ड अ में 5 प्रश्न हैं, प्रत्येक का 1 अंक है। खण्ड ब में 5 प्रश्न हैं, प्रत्येक के 2 अंक हैं। खण्ड स में 12 प्रश्न हैं, प्रत्येक के 3 अंक हैं। खण्ड द में 4 अंक का एक मूल्याधारित प्रश्न है और खण्ड य में 3 प्रश्न हैं, प्रत्येक के 5 अंक हैं।
- (iv) प्रश्न-पत्र में समग्र पर कोई विकल्प नहीं है। तथापि, दो अंकों वाले एक प्रश्न में, तीन अंकों वाले एक प्रश्न में और पाँच अंकों वाले तीनों प्रश्नों में आन्तरिक चयन प्रदान किया गया है। ऐसे प्रश्नों में आपको दिए गए चयन में से केवल एक प्रश्न ही करना है।
- (v) जहाँ आवश्यक हो आप निम्नलिखित भौतिक नियतांकों के मानों का उपयोग कर सकते हैं :

$$c = 3 \times 10^8 \text{ m/s}$$

$$h = 6.63 \times 10^{-34} \text{ Js}$$

$$e = 1.6 \times 10^{-19} \text{ C}$$

$$\mu_0 = 4\pi \times 10^{-7} \text{ T m A}^{-1}$$

$$\epsilon_0 = 8.854 \times 10^{-12} \text{ C}^2 \text{ N}^{-1} \text{ m}^{-2}$$

$$\frac{1}{4\pi\epsilon_0} = 9 \times 10^9 \text{ N m}^2 \text{ C}^{-2}$$

$$m_e = 9.1 \times 10^{-31} \text{ kg}$$

$$\text{न्यूट्रॉन का द्रव्यमान} = 1.675 \times 10^{-27} \text{ kg}$$

$$\text{प्रोटॉन का द्रव्यमान} = 1.673 \times 10^{-27} \text{ kg}$$

$$\text{आवोगाद्रो संख्या} = 6.023 \times 10^{23} \text{ प्रति ग्राम मोल}$$

$$\text{बोल्ट्ज़मान नियतांक} = 1.38 \times 10^{-23} \text{ JK}^{-1}$$



General Instructions :

- (i) *All questions are compulsory. There are **26** questions in all.*
- (ii) *This question paper has **five** sections : Section A, Section B, Section C, Section D and Section E.*
- (iii) *Section A contains **five** questions of **one** mark each, Section B contains **five** questions of **two** marks each, Section C contains **twelve** questions of **three** marks each, Section D contains one value based question of **four** marks and Section E contains **three** questions of **five** marks each.*
- (iv) *There is no overall choice. However, an internal choice has been provided in one question of two marks, one question of three marks and all the three questions of five marks weightage. You have to attempt only one of the choices in such questions.*
- (v) *You may use the following values of physical constants wherever necessary :*

$$c = 3 \times 10^8 \text{ m/s}$$

$$h = 6.63 \times 10^{-34} \text{ Js}$$

$$e = 1.6 \times 10^{-19} \text{ C}$$

$$\mu_0 = 4\pi \times 10^{-7} \text{ T m A}^{-1}$$

$$\epsilon_0 = 8.854 \times 10^{-12} \text{ C}^2 \text{ N}^{-1} \text{ m}^{-2}$$

$$\frac{1}{4\pi\epsilon_0} = 9 \times 10^9 \text{ N m}^2 \text{ C}^{-2}$$

$$m_e = 9.1 \times 10^{-31} \text{ kg}$$

$$\text{Mass of neutron} = 1.675 \times 10^{-27} \text{ kg}$$

$$\text{Mass of proton} = 1.673 \times 10^{-27} \text{ kg}$$

$$\text{Avogadro's number} = 6.023 \times 10^{23} \text{ per gram mole}$$

$$\text{Boltzmann constant} = 1.38 \times 10^{-23} \text{ JK}^{-1}$$



खण्ड अ

SECTION A

1. आवेश वाहकों की 'गतिशीलता' पद को परिभाषित कीजिए। इसका एस.आई. (S.I.) मात्रक लिखिए। 1
Define the term 'mobility' of charge carriers. Write its S.I. unit.
2. किसी श्रेणी एल.सी.आर. (LCR) परिपथ में, $V_L = V_C \neq V_R$ है। शक्ति गुणांक का मान क्या है? 1
In a series LCR circuit, $V_L = V_C \neq V_R$. What is the value of power factor?
3. किसी उभयोत्तल लेंस की फोकस दूरी उसके दोनों पृष्ठों की वक्रता त्रिज्या के बराबर है। लेंस के पदार्थ के अपवर्तनांक का मान क्या है? 1
The focal length of an equiconvex lens is equal to the radius of curvature of either face. What is the refractive index of the material of the lens?
4. बाह्य विद्युत्-क्षेत्र \vec{E} की उपस्थिति में किसी परावैद्युत पदार्थ के ध्रुवण \vec{P} के लिए सम्बन्ध लिखिए। 1
Write a relation for polarisation \vec{P} of a dielectric material in the presence of an external electric field \vec{E} .
5. किसी p-n संधि को अग्र बायसित करने पर क्या होता है? 1
What happens when a forward bias is applied to a p-n junction?

खण्ड ब

SECTION B

6. (a) संचार के 'एनालॉग' (अनुरूप) तथा 'डिजिटल' (अंकीय) प्रकारों में अन्तर (भेद) कीजिए (लिखिए)।
(b) 'इंटरनेट' में दो सामान्य प्रयुक्त अनुप्रयोगों को संक्षेप में स्पष्ट कीजिए। 2
(a) Distinguish between 'Analog' and 'Digital' forms of communication.
(b) Explain briefly two commonly used applications of the 'Internet'.

7. दिया गया है निम्नतम अवस्था ऊर्जा, $E_0 = -13.6 \text{ eV}$ तथा बोर त्रिज्या, $a_0 = 0.53 \text{ \AA}$ । इससे ज्ञात कीजिए कि निम्नतम अवस्था में चक्कर लगाते हुए इलेक्ट्रॉन के प्रथम उत्तेजित अवस्था में संक्रमण से इस इलेक्ट्रॉन से सम्बद्ध दे ब्रॉग्ली तरंगदैर्घ्य के मान में क्या परिवर्तन होगा ।

2

Given the ground state energy $E_0 = -13.6 \text{ eV}$ and Bohr radius $a_0 = 0.53 \text{ \AA}$. Find out how the de Broglie wavelength associated with the electron orbiting in the ground state would change when it jumps into the first excited state.

8. हाइड्रोजन परमाणु (एटम) के लिए बोर के उस अभिगृहीत को लिखिए जिसके आधार पर हाइड्रोजन परमाणु के स्पेक्ट्रम में उत्सर्जन रेखाओं की सफलतापूर्वक व्याख्या की जा सकती है । रिडबर्ग सूत्र के उपयोग से H_α रेखा की तरंगदैर्घ्य का मान ज्ञात कीजिए ।

[दिया गया है : रिडबर्ग नियतांक $R = 1.03 \times 10^7 \text{ m}^{-1}$]

2

State Bohr's postulate of hydrogen atom which successfully explains the emission lines in the spectrum of hydrogen atom.

Use Rydberg formula to determine the wavelength of H_α line.

[Given : Rydberg constant $R = 1.03 \times 10^7 \text{ m}^{-1}$]

9. विद्युत् परिपथों (जालों) में प्रयुक्त किरखोफ़ के दो नियमों का उल्लेख कीजिए तथा इनकी पुष्टि के लिए कारण लिखिए ।

2

State the two Kirchhoff's rules used in electric networks. How are these rules justified ?

10. उन महत्वपूर्ण विशिष्ट लक्षणों का उल्लेख कीजिए जिनसे व्यतिकरण तथा प्रेक्षित विवर्तन पैटर्न में अन्तर (भेद) किया जा सकता है ।

2

अथवा

दूरदर्शी तथा सूक्ष्मदर्शी की संरचना तथा कार्यविधि के बीच मूल अन्तरों को स्पष्ट कीजिए ।

2

Write the important characteristic features by which the interference can be distinguished from the observed diffraction pattern.

OR

Explain the basic differences between the construction and working of a telescope and a microscope.



SECTION C

11. किसी प्रकाश-संवेदी पृष्ठ पर 'I' तीव्रता तथा 'ν' आवृत्ति का प्रकाश आपतित होने से प्रकाश-विद्युत् उत्सर्जन होता है। ऐनोड विद्युत् धारा पर क्या प्रभाव होगा, जब प्रत्येक दशा में अन्य सभी प्राचलों को अपरिवर्तित रखते हुए (i) प्रकाश की तीव्रता को धीरे-धीरे बढ़ाया जाए, (ii) आपतित विकिरण की आवृत्ति को बढ़ाया जाए, और (iii) ऐनोड विभव को बढ़ाया जाए ? प्रत्येक दशा में कारण लिखकर अपने उत्तर की पुष्टि कीजिए।

3

Light of intensity 'I' and frequency 'ν' is incident on a photosensitive surface and causes photoelectric emission. What will be the effect on anode current when (i) the intensity of light is gradually increased, (ii) the frequency of incident radiation is increased, and (iii) the anode potential is increased ? In each case, all other factors remain the same.

Explain, giving justification in each case.

12. किसी ट्रांज़िस्टर को सक्रिय अवस्था में कब कहा जाता है ? p-n-p ट्रांज़िस्टर का एक परिपथ आरेख बनाकर स्पष्ट कीजिए कि यह ट्रांज़िस्टर प्रवर्धक की भाँति कैसे कार्य करता है। स्पष्टतः लिखिए कि किसी ट्रांज़िस्टर का (i) आधार पतला तथा कम अपमिश्रित और (ii) उत्सर्जक अत्यधिक अपमिश्रित क्यों होता है।

3

When is a transistor said to be in active state ? Draw a circuit diagram of a p-n-p transistor and explain how it works as a transistor amplifier. Write clearly, why in the case of a transistor (i) the base is thin and lightly doped and (ii) the emitter is heavily doped.

13. (a) प्रसारण से पहले किसी अल्प (कम) आवृत्ति संकेत को उच्च आवृत्ति तरंग में परिवर्तित करने की आवश्यकता के लिए तीन महत्वपूर्ण कारकों का उल्लेख कीजिए।
- (b) एक माडुलक संकेत के साथ किसी ज्यावक्रीय वाहक तरंग का एक रेखाचित्र बनाइए और दर्शाइए कि इनके अध्यारोपण से परिणामी आयाम माडुलित तरंग कैसे प्राप्त होती है।
- (a) State three important factors showing the need for translating a low frequency signal into a high frequency wave before transmission.
- (b) Draw a sketch of a sinusoidal carrier wave along with a modulating signal and show how these are superimposed to obtain the resultant amplitude modulated wave.

3



14. आपको तीन परिपथ अवयव X, Y तथा Z दिए गए हैं। जब अवयव X को निश्चित वोल्टता के ए.सी. (a.c.) स्रोत के दो सिरों से जोड़ा जाता है, तो धारा तथा वोल्टता समान (एक ही) कला में होते हैं। जब अवयव Y को X के साथ श्रेणीक्रम में जोड़कर स्रोत के दो सिरों से संयोजित किया जाता है, तो वोल्टता कला में विद्युत् धारा से $\pi/4$ आगे रहती है। परन्तु, Y के स्थान पर Z को X के साथ श्रेणीक्रम में जोड़ने से धारा कला में वोल्टता से $\pi/4$ आगे रहती है। परिपथ अवयवों X, Y तथा Z को पहचानिए।

जब इन तीनों अवयवों के श्रेणीक्रम में संयोजन को, उसी स्रोत के सिरों से जोड़ दिया जाए, तो परिपथ की प्रतिबाधा निर्धारित कीजिए।

अनुप्रयुक्त स्रोत की आवृत्ति तथा धारा के बीच एक ग्राफ बनाइए और इस ग्राफ के महत्त्व का उल्लेख कीजिए।

3

You are given three circuit elements X, Y and Z. When the element X is connected across an a.c. source of a given voltage, the current and the voltage are in the same phase. When the element Y is connected in series with X across the source, voltage is ahead of the current in phase by $\pi/4$. But the current is ahead of the voltage in phase by $\pi/4$ when Z is connected in series with X across the source. Identify the circuit elements X, Y and Z.

When all the three elements are connected in series across the same source, determine the impedance of the circuit.

Draw a plot of the current versus the frequency of applied source and mention the significance of this plot.

15. दो भिन्न पदार्थों के चालकों के लिए, विद्युत्-क्षेत्र (E) के साथ धारा घनत्व (j) के परिवर्तन को दर्शाने के लिए एक ग्राफ (आलेख) बनाइए। इस ग्राफ से चालक-पदार्थ के उन गुणों के बारे में क्या सूचना मिल सकती है, जिनका उपयोग विद्युत् परिपथों में (i) मानक प्रतिरोध तथा (ii) चालक तार बनाने में उपयुक्त पदार्थों के चयन में किया जा सकता है ?

इलेक्ट्रॉनों की अपवाह चाल का मान mm s^{-1} की कोटि का आकलित किया गया है। फिर भी किसी तार में कुछ ऐम्पियर की कोटि की बृहत् धारा स्थापित की जा सकती है। संक्षेप में स्पष्ट कीजिए।

3

Plot a graph showing the variation of current density (j) versus the electric field (E) for two conductors of different materials. What information from this plot regarding the properties of the conducting



material, can be obtained which can be used to select suitable materials for use in making (i) standard resistance and (ii) connecting wires in electric circuits ?

Electron drift speed is estimated to be of the order of mm s^{-1} . Yet large current of the order of few amperes can be set up in the wire. Explain briefly.

16. बायो – सावर्ट नियम को लिखिए । 'R' त्रिज्या के किसी धारावाही वृत्ताकार लूप (पाश) की अक्ष पर तथा उसके केन्द्र से 'x' दूरी पर स्थित किसी बिन्दु पर, चुम्बकीय क्षेत्र के लिए व्यंजक प्राप्त कीजिए । इससे पाश के केन्द्र पर चुम्बकीय क्षेत्र के लिए व्यंजक लिखिए ।

3

State Biot – Savart law. Deduce the expression for the magnetic field at a point on the axis of a current carrying circular loop of radius 'R', distant 'x' from the centre. Hence write the magnetic field at the centre of a loop.

17. पोलैरॉइड की संरचना कैसी होती है ? सामान्य पोलैरॉइड द्वारा दर्शाइए कि प्रकाश की तरंगों की प्रकृति अनुप्रस्थ होती है । किसी पोलैरॉइड से पारगमित प्रकाश की तीव्रता में कोई परिवर्तन नहीं होता, भले ही (चाहे) पोलैरॉइड की पारित अक्ष का अभिविन्यास कुछ भी हो । स्पष्ट कीजिए क्यों ।

3

What does a polaroid consist of? Show, using a simple polaroid, that light waves are transverse in nature. Intensity of light coming out of a polaroid does not change irrespective of the orientation of the pass axis of the polaroid. Explain why.

18. ज़ेनर डायोड का संविरचन कैसे होता है ? डायोड के सिरों के बीच अल्प-पश्चदिशिक बायस वोल्टता होने पर भी उच्च विद्युत्-क्षेत्र कैसे उत्पन्न हो जाता है ?

एक परिपथ आरेख की सहायता से ज़ेनर डायोड की वोल्टता नियंत्रक के रूप में कार्यविधि का वर्णन कीजिए ।

3

अथवा

- (a) आरेख की सहायता से स्पष्ट कीजिए कि किसी संधि डायोड में हासी क्षेत्र और विभव प्राचीर किस प्रकार बनते हैं ।
- (b) यदि किसी p-n संधि डायोड पर कोई लघु वोल्टता अनुप्रयुक्त की जाए, तो इसके रोधिका विभव पर क्या प्रभाव होगा, जब यह (i) अग्रदिशिक बायसित है, और (ii) पश्चदिशिक बायसित है ?

3



How is a Zener diode fabricated ? What causes the setting up of high electric field even for small reverse bias voltage across the diode ?

Describe, with the help of a circuit diagram, the working of Zener diode as a voltage regulator.

OR

- (a) Explain with the help of a diagram, how depletion region and potential barrier are formed in a junction diode.
- (b) If a small voltage is applied to a p-n junction diode how will the barrier potential be affected when it is (i) forward biased, and (ii) reverse biased ?

19. निम्नलिखित विद्युत्-चुम्बकीय तरंगों को उनके बढ़ते हुए तरंगदैर्घ्य के क्रम में व्यवस्थित कीजिए :

- (a) γ -(गामा) किरणें
- (b) सूक्ष्मतरंगें
- (c) एक्स-किरणें
- (d) रेडियो तरंगें

अवरक्त तरंगें कैसे उत्पन्न होती हैं ? अवरक्त विकिरणों की (i) पृथ्वी के ताप के संधारण (संपोषण) में तथा (ii) भौतिक रोगोपचार में क्या भूमिका है ?

3

Arrange the following electromagnetic waves in the order of their increasing wavelength :

- (a) γ -rays
- (b) Microwaves
- (c) X-rays
- (d) Radio waves

How are infra-red waves produced ? What role does infra-red radiation play in (i) maintaining the Earth's warmth and (ii) physical therapy ?



20. डी.सी. (d.c.) बैटरी से जोड़ने पर किसी समान्तर पट्टिका संधारित्र के आवेशित होने के प्रक्रम को संक्षेप में स्पष्ट कीजिए ।
 किसी संधारित्र की धारिता 'C' है । एक बैटरी द्वारा इसे 'V' वोल्ट तक आवेशित किया जाता है । कुछ समय पश्चात् बैटरी को हटाकर संधारित्र की पट्टिकाओं के बीच की दूरी को पहले की अपेक्षा दुगुना कर दिया जाता है । फिर इन पट्टिकाओं के बीच के स्थान को एक परावैद्युत स्लैब (पट्ट) द्वारा भर दिया जाता है जिसके परावैद्युतांक (k) का मान $1 < k < 2$ है । इससे निम्नलिखित पर क्या प्रभाव पड़ेगा :

- संधारित्र की पट्टिकाओं के बीच विद्युत्-क्षेत्र
- संधारित्र में संचित ऊर्जा

अपने उत्तर की पुष्टि के लिए आवश्यक व्यंजक लिखिए ।

3

Explain briefly the process of charging a parallel plate capacitor when it is connected across a d.c. battery.

A capacitor of capacitance 'C' is charged to 'V' volts by a battery. After some time the battery is disconnected and the distance between the plates is doubled. Now a slab of dielectric constant, $1 < k < 2$, is introduced to fill the space between the plates. How will the following be affected :

- The electric field between the plates of the capacitor
- The energy stored in the capacitor

Justify your answer by writing the necessary expressions.

21. ${}^{11}_6\text{C}$ के नाभिकीय β^+ विघटन (क्षय) प्रक्रम को प्रतीकात्मक रूप में लिखिए । क्या उत्पादित विघटनज X, ${}^{11}_6\text{C}$ का समस्थानिक है या समभारिक ?

दिया गया है द्रव्यमान मान, $m({}^{11}_6\text{C}) = 11.011434 \text{ u}$ तथा $m(\text{X}) = 11.009305 \text{ u}$.

इस प्रक्रम का Q-मान आकलित कीजिए ।

3

Write symbolically the nuclear β^+ decay process of ${}^{11}_6\text{C}$. Is the decayed product X an isotope or isobar of ${}^{11}_6\text{C}$?

Given the mass values $m({}^{11}_6\text{C}) = 11.011434 \text{ u}$ and $m(\text{X}) = 11.009305 \text{ u}$.

Estimate the Q-value in this process.



22. 10 cm फोकस दूरी के किसी उत्तल लेंस के सामने एक वस्तु लेंस से 15 cm दूर रखी है। इससे बने प्रतिबिम्ब की स्थिति तथा प्रकृति ज्ञात कीजिए। इस व्यवस्था में 20 cm वक्रता त्रिज्या के किसी अवतल दर्पण को कहाँ पर रखा जाए ताकि अन्तिम प्रतिबिम्ब, वस्तु की स्थिति पर ही बने ?

3

An object is placed 15 cm in front of a convex lens of focal length 10 cm. Find the nature and position of the image formed. Where should a concave mirror of radius of curvature 20 cm be placed so that the final image is formed at the position of the object itself ?

खण्ड द

SECTION D

23. अजीत के खेतों में विद्युत् का हाई टेंशन टावर लगा था। उसने अधिकारियों से इसे हटाने की कई बार प्रार्थना की क्योंकि इस टावर ने खेती की बहुत सी ज़मीन घेर रखी थी। अजीत के चाचाजी ने, जो एक शिक्षक थे, उसे समझाया कि विद्युत् शक्ति के दक्ष प्रसारण में इन टावरों का क्या महत्त्व है। अजीत को जब इस टावर का महत्त्व समझ में आ गया, तो उसने टावर हटाने के लिए प्रार्थना करना बन्द कर दिया।

निम्नलिखित प्रश्नों के उत्तर दीजिए :

4

- विद्युत् शक्ति के परिवहन के लिए उच्च वोल्टता क्यों आवश्यक है ?
- निम्न शक्ति गुणांक का तात्पर्य अधिक ऊर्जा क्षय है। स्पष्ट कीजिए।
- अजीत तथा उसके चाचाजी द्वारा प्रदर्शित दो मूल्यों को लिखिए।

Ajit had a high tension tower erected on his farm land. He kept complaining to the authorities to remove it as it was occupying a large portion of his land. His uncle, who was a teacher, explained to him the need for erecting these towers for efficient transmission of power. As Ajit realized its significance, he stopped complaining.

Answer the following questions :

- Why is it necessary to transport power at high voltage ?
- A low power factor implies large power loss. Explain.
- Write two values each displayed by Ajit and his uncle.



खण्ड य
SECTION E

24. (a) किसी बाह्य विद्युत्-क्षेत्र में एक निकाय (सिस्टम) के दो आवेश q_1 तथा q_2 , क्रमशः \vec{r}_1 तथा \vec{r}_2 पर स्थित हैं। इस निकाय की स्थितिज ऊर्जा के लिए व्यंजक प्राप्त कीजिए।
- (b) एक समबाहु त्रिभुज ABC की प्रत्येक भुजा की लम्बाई l है। इसके शीर्षों पर क्रमशः $+Q$, $+2Q$ तथा $-3Q$, तीन बिन्दु आवेश रखे गए हैं। यदि इन आवेशों को क्रमशः A_1 , B_1 तथा C_1 पर विस्थापित किया जाए, तो इस नई स्थिति में लाने में कितना कार्य करना होगा, जहाँ A_1 , B_1 तथा C_1 क्रमशः AB, BC तथा CA के मध्य-बिन्दु हैं ?

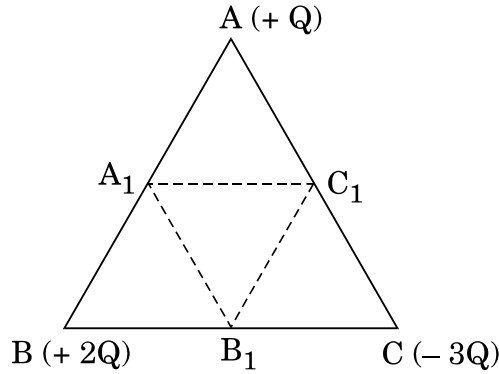

अथवा

विद्युत् फ्लक्स की परिभाषा दीजिए। इसका एस.आई. (S.I.) मात्रक लिखिए। गाउस के नियम का उल्लेख और व्याख्या कीजिए। किसी घनाकार आकृति की भुजा 'a' है। इसके केन्द्र पर स्थित किसी बिन्दु आवेश $+q$ के कारण बाहर की ओर फ्लक्स ज्ञात कीजिए। इसका मान आवेश को परिबद्ध (बन्द) करने वाले पृष्ठ के साइज़ (आमाप) तथा आकार पर निर्भर क्यों नहीं करता ? स्पष्ट कीजिए।

- (a) Deduce the expression for the potential energy of a system of two charges q_1 and q_2 located at \vec{r}_1 and \vec{r}_2 respectively in an external electric field.

- (b) Three point charges, $+Q$, $+2Q$ and $-3Q$ are placed at the vertices of an equilateral triangle ABC of side l . If these charges are displaced to the mid-points A_1 , B_1 and C_1 respectively, find the amount of the work done in shifting the charges to the new locations.

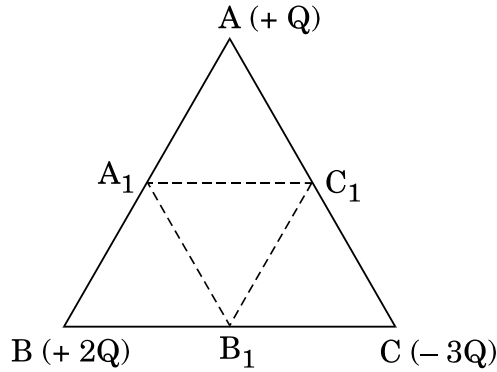

OR

Define electric flux. Write its S.I. unit.

State and explain Gauss's law. Find out the outward flux due to a point charge $+q$ placed at the centre of a cube of side 'a'. Why is it found to be independent of the size and shape of the surface enclosing it? Explain.

25. (a) किसी कुंडली के स्व-प्रेरकत्व को परिभाषित कीजिए। किसी परिनालिका का स्व-प्रेरकत्व 'L' है। इससे प्रवाहित विद्युत् धारा का मान शून्य से 'I' तक बढ़ने पर, इसमें संचित ऊर्जा के मान के लिए एक व्यंजक प्राप्त कीजिए।
- (b) 20 cm भुजा के एक वर्गाकार पाश (लूप) MNOP को क्षैतिज रूप में आरेख में दर्शाए गए अनुसार, किसी एकसमान चुम्बकीय क्षेत्र में रखा गया है। चुम्बकीय क्षेत्र की दिशा ऊर्ध्वाधर (सीधे) नीचे की ओर है। इस पाश को 20 cm s^{-1} के अचर वेग से खींचा जाता है ताकि वह चुम्बकीय क्षेत्र से बाहर निकल जाए।

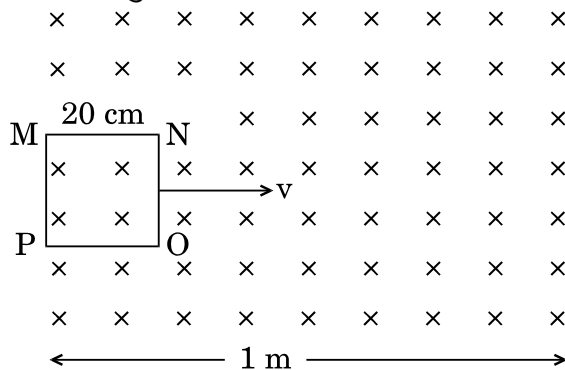

- (i) चुम्बकीय क्षेत्र से बाहर निकलते हुए, इस लूप में प्रेरित विद्युत् धारा की दिशा को दर्शाइए। इस पाश (लूप) में विद्युत् धारा कब तक बनी रहेगी?

- (ii) समय के फलन के रूप में (साथ) चुम्बकीय फ्लक्स तथा प्रेरित विद्युत्-वाहक बल (ई.एम.एफ.) के परिवर्तन (विचलन) को दर्शाने के लिए एक ग्राफ बनाइए ।

5

अथवा

- (a) किसी वृत्ताकार पाश का क्षेत्रफल \vec{A} है और इससे I धारा प्रवाहित हो रही है । इसके कारण चुम्बकीय क्षेत्र रेखाओं को दर्शाइए (बनाइए) । यह दर्शाइए कि यह लूप (पाश) एक ऐसे छड़ चुम्बक की भाँति व्यवहार करता है जिसका चुम्बकीय आघूर्ण $\vec{m} = I \vec{A}$ ।
- (b) किसी परिनालिका की लम्बाई '2l' है, इसकी त्रिज्या 'a' है, इसकी प्रति एकांक लम्बाई में तारों के फेरों की संख्या 'n' है तथा इससे एक स्थिर धारा 'I' प्रवाहित हो रही है । इसकी अक्ष रेखा पर तथा परिनालिका के केन्द्र से 'r' दूरी पर स्थित किसी बिन्दु पर, चुम्बकीय क्षेत्र के लिए व्यंजक व्युत्पन्न कीजिए । इस व्यंजक की तुलना, 'm' चुम्बकीय आघूर्ण के छड़ (दंड) चुम्बक के कारण अक्षीय चुम्बकीय क्षेत्र से कीजिए ।

5

- (a) Define self-inductance of a coil. Obtain an expression for the energy stored in a solenoid of self-inductance 'L' when the current through it grows from zero to 'I'.
- (b) A square loop MNOP of side 20 cm is placed horizontally in a uniform magnetic field acting vertically downwards as shown in the figure. The loop is pulled with a constant velocity of 20 cm s⁻¹ till it goes out of the field.

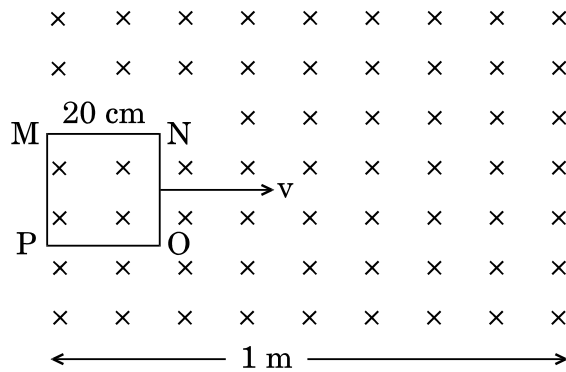

- (i) Depict the direction of the induced current in the loop as it goes out of the field. For how long would the current in the loop persist ?
- (ii) Plot a graph showing the variation of magnetic flux and induced emf as a function of time.

OR



- (a) Draw the magnetic field lines due to a circular loop of area \vec{A} carrying current I . Show that it acts as a bar magnet of magnetic moment $\vec{m} = I \vec{A}$.
- (b) Derive the expression for the magnetic field due to a solenoid of length ' $2l$ ', radius ' a ' having ' n ' number of turns per unit length and carrying a steady current ' I ' at a point on the axial line, distant ' r ' from the centre of the solenoid. How does this expression compare with the axial magnetic field due to a bar magnet of magnetic moment ' m '?

26. (a) यंग के द्वि-झिरी प्रयोग में, संपोषी तथा विनाशी व्यतिकरण फ्रिंजों के लिए प्रतिबन्धों (शर्तों) को प्राप्त कीजिए। इससे फ्रिंज की चौड़ाई के लिए व्यंजक व्युत्पन्न कीजिए।
- (b) दर्शाइए कि इस प्रयोग में पर्दे पर प्राप्त फ्रिंज पैटर्न, वास्तव में दोनों एकल झिरियों से प्राप्त विवर्तन पैटर्नों का अध्यारोपण है।
- (c) द्वि-झिरी पैटर्न में प्रत्येक झिरी (स्लिट) की चौड़ाई कितनी होनी चाहिए जिससे उसके 10 उच्चिष्ठ किसी एकल झिरी के पैटर्न के केन्द्रीय उच्चिष्ठ के अन्दर प्राप्त हो सकें, जब दो झिरियों के बीच की दूरी 1 mm है तथा प्रयुक्त प्रकाश 500 nm तरंगदैर्घ्य का हरा प्रकाश है ?

5

अथवा

- (a) दो पतले उत्तल लेंसों L_1 तथा L_2 की फोकस दूरियाँ क्रमशः f_1 तथा f_2 हैं। इन्हें इस प्रकार सम्पर्क में रखा गया है कि इनकी अक्ष सम्पाती (एक ही) है। एक वस्तु लेंस L_1 के फोकस के परे (बाहर) किसी बिन्दु पर रखी है। लेंस के इस संयोजन द्वारा, इस वस्तु का प्रतिबिम्ब बनना दर्शाने के लिए एक किरण आरेख बनाइए और इससे इस संयोजन की फोकस दूरी के लिए व्यंजक प्राप्त कीजिए।
- (b) यहाँ आरेख में दर्शाए गए अनुसार किसी प्रिज़म ABC के फलक AB पर प्रकाश की एक किरण PQ आपतित होती है और फलक AC से इस प्रकार निर्गत होती है कि $AQ = AR$.

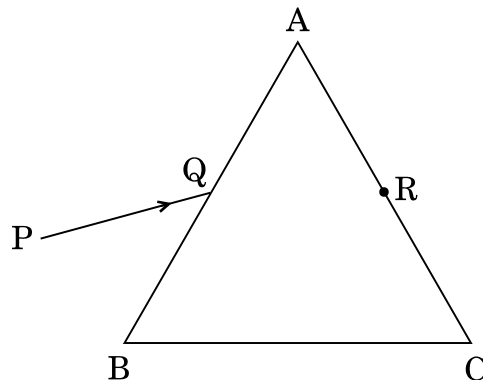

प्रिज़्म में से इस किरण के मार्ग को दर्शाने के लिए किरण आरेख बनाइए। यदि प्रिज़्म का कोण 60° है और प्रिज़्म के पदार्थ का अपवर्तनांक $\sqrt{3}$ है, तो आपतन कोण तथा विचलन कोण का मान ज्ञात कीजिए।

5

- In Young's double slit experiment, deduce the conditions for obtaining constructive and destructive interference fringes. Hence deduce the expression for the fringe width.
- Show that the fringe pattern on the screen is actually a superposition of single slit diffraction from each slit.
- What should be the width of each slit to obtain 10 maxima of the double slit pattern within the central maximum of the single slit pattern, for green light of wavelength 500 nm, if the separation between two slits is 1 mm ?

OR

- Two thin convex lenses L_1 and L_2 of focal lengths f_1 and f_2 respectively, are placed coaxially in contact. An object is placed at a point beyond the focus of lens L_1 . Draw a ray diagram to show the image formation by the combination and hence derive the expression for the focal length of the combined system.
- A ray PQ incident on the face AB of a prism ABC, as shown in the figure, emerges from the face AC such that $AQ = AR$.

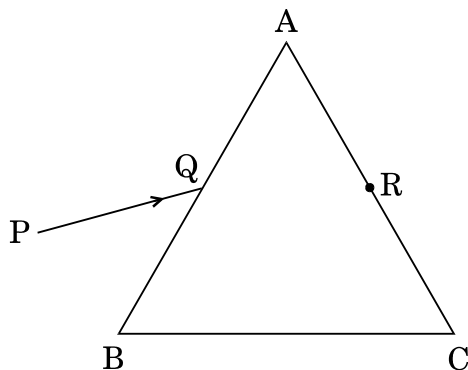

Draw the ray diagram showing the passage of the ray through the prism. If the angle of the prism is 60° and refractive index of the material of the prism is $\sqrt{3}$, determine the values of angle of incidence and angle of deviation.



MARKING SCHEME
SET 55/1/C

Q. No.	Expected Answer / Value Points	Marks	Total Mark
--------	--------------------------------	-------	------------

Section - A

et-1, Q1 et-2, Q5 et-3, Q2	Power factor = 1	1	1
et-1, Q2 et-2, Q4 et-3, Q5	i) Width of depletion layer will decrease ii) potential barrier will decrease iii) junction will conduct (Any one point)	1	1
et-1, Q3 et-2, Q2 et-3, Q4	$\vec{P} = \epsilon_0 X_e \vec{E}$ (Also accept if the student writes $\vec{P} \propto \vec{E}$ or $\vec{P} = X_e \vec{E}$)	1	1
et-1, Q4 et-2, Q3 et-3, Q1	Mobility is defined as drift velocity per unit electric field or $\mu = \frac{v_d}{E}$ S.I. Unit - m^2/Vs or Cm/Ns	1/2 1/2	1
et-1, Q5 et-2, Q1 et-3, Q3	$\frac{1}{f} = (\mu - 1) \left(\frac{1}{R_1} - \frac{1}{R_2} \right)$ $\therefore \mu = 1.5$ (Award 1 mark even if direct answer is written)	1/2 1/2	1

Section - B

et-1, Q6 et-2, Q7 et-3, Q10	<table border="1" style="width: 100%; border-collapse: collapse;"> <tr> <td style="width: 10%;"></td> <td style="width: 60%;">Two differences between Interference and Diffraction pattern</td> <td style="width: 10%; text-align: center;">2</td> </tr> <tr> <td></td> <td style="text-align: center;"> <table border="1" style="width: 100%; border-collapse: collapse;"> <thead> <tr> <th style="width: 5%;"></th> <th style="width: 45%;">Interference</th> <th style="width: 50%;">Diffraction</th> </tr> </thead> <tbody> <tr> <td style="text-align: center;">1</td> <td>All the bright bands are of same intensity.</td> <td>Intensity of bright bands goes on decreasing with increasing order.</td> </tr> <tr> <td style="text-align: center;">2</td> <td>All the bright bands are of same width.</td> <td>Not of same width.</td> </tr> <tr> <td style="text-align: center;">3</td> <td>Dark bands may be completely dark.</td> <td>Not completely dark.</td> </tr> <tr> <td style="text-align: center;">4</td> <td>Number of fringes are more.</td> <td>Less in number.</td> </tr> </tbody> </table> </td> <td></td> </tr> </table>		Two differences between Interference and Diffraction pattern	2		<table border="1" style="width: 100%; border-collapse: collapse;"> <thead> <tr> <th style="width: 5%;"></th> <th style="width: 45%;">Interference</th> <th style="width: 50%;">Diffraction</th> </tr> </thead> <tbody> <tr> <td style="text-align: center;">1</td> <td>All the bright bands are of same intensity.</td> <td>Intensity of bright bands goes on decreasing with increasing order.</td> </tr> <tr> <td style="text-align: center;">2</td> <td>All the bright bands are of same width.</td> <td>Not of same width.</td> </tr> <tr> <td style="text-align: center;">3</td> <td>Dark bands may be completely dark.</td> <td>Not completely dark.</td> </tr> <tr> <td style="text-align: center;">4</td> <td>Number of fringes are more.</td> <td>Less in number.</td> </tr> </tbody> </table>		Interference	Diffraction	1	All the bright bands are of same intensity.	Intensity of bright bands goes on decreasing with increasing order.	2	All the bright bands are of same width.	Not of same width.	3	Dark bands may be completely dark.	Not completely dark.	4	Number of fringes are more.	Less in number.			
	Two differences between Interference and Diffraction pattern	2																						
	<table border="1" style="width: 100%; border-collapse: collapse;"> <thead> <tr> <th style="width: 5%;"></th> <th style="width: 45%;">Interference</th> <th style="width: 50%;">Diffraction</th> </tr> </thead> <tbody> <tr> <td style="text-align: center;">1</td> <td>All the bright bands are of same intensity.</td> <td>Intensity of bright bands goes on decreasing with increasing order.</td> </tr> <tr> <td style="text-align: center;">2</td> <td>All the bright bands are of same width.</td> <td>Not of same width.</td> </tr> <tr> <td style="text-align: center;">3</td> <td>Dark bands may be completely dark.</td> <td>Not completely dark.</td> </tr> <tr> <td style="text-align: center;">4</td> <td>Number of fringes are more.</td> <td>Less in number.</td> </tr> </tbody> </table>		Interference	Diffraction	1	All the bright bands are of same intensity.	Intensity of bright bands goes on decreasing with increasing order.	2	All the bright bands are of same width.	Not of same width.	3	Dark bands may be completely dark.	Not completely dark.	4	Number of fringes are more.	Less in number.								
	Interference	Diffraction																						
1	All the bright bands are of same intensity.	Intensity of bright bands goes on decreasing with increasing order.																						
2	All the bright bands are of same width.	Not of same width.																						
3	Dark bands may be completely dark.	Not completely dark.																						
4	Number of fringes are more.	Less in number.																						
	(Any two) [Award only 1 mark if student draws intensity distribution curves for both without writing points]	1×2	2																					

Or

Difference in Construction - 1
Difference in Working - 1

	Microscope	Telescope
Construction	Objective is of very short focal length and short aperture and eye piece of short focal length and large aperture. [$f_e > f_o$]	Objective is of large focal length and large aperture but eye piece of short focal length and short aperture.
Working	It will form magnified image of a small nearby object. (Object is placed close to focus of objective which forms real and magnified image.)	It will form magnified image of distant object. (Objective will form the image of distant object at its focus and image is diminished.)

1/2+
1/2

1/2+
1/2

2

et-1, Q7
et-2, Q10
et-3, Q8

Postulate - 1
Formula for H'_α line - 1/2
Substitution and calculation- 1/2

Postulate- Energy is radiated when an electron jumps from a (permitted) higher to lower orbit and it equal to the difference in energy in the two orbits.

$$h\nu = E_i - E_f$$

$$\frac{1}{\lambda_\alpha} = R_H \left[\frac{1}{2^2} - \frac{1}{3^2} \right]$$

$$= 1.03 \times 10^7 \times \frac{5}{36} \quad \therefore \lambda_\alpha = 6.99 \times 10^{-7} \text{ m} = 699 \text{ nm}$$

[Award 1/2 mark if student only writes $\frac{1}{\lambda} = R_H \left[\frac{1}{n_f^2} - \frac{1}{n_i^2} \right]$

1

1/2







1/2

2

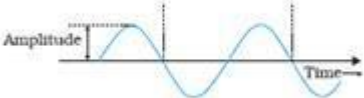

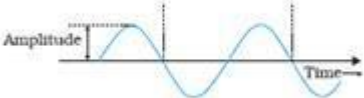
et-1, Q8 et-2, Q6 et-3, Q9	<div style="border: 1px solid black; padding: 5px; margin-bottom: 10px;"> Kirchhoff's laws ½+½ To justify them ½+½ </div> <p>Kirchhoff's I Law: (JUNCTION LAW) Sum of the incoming currents at a junction = Sum of outgoing currents</p> <p>[Alternatively] Algebraic sum of all the currents meeting at a junction in the electrical circuit is zero]</p> <p>2nd Law : (LOOP LAW) The algebraic sum of the changes in potential around any closed loop involving resistors and cells in the loop is zero</p> <p>[Alternatively] In any closed electrical part of circuit, sum of the e.m.f s is equal to sum of products of various currents and resistances through which currents pass.]</p> <p>To justify First law is based on the law of conservation of charge.</p> <p>Second Law is based on the law of conservation of energy.</p>	½ ½ ½ ½	2				
et-1, Q9 et-2, Q8 et-3, Q7	<div style="border: 1px solid black; padding: 5px; margin-bottom: 10px;"> Formula for de Broglie wavelength – 1 Calculation and result – 1 </div> <p>Formula used $\lambda = \frac{h}{mv} = \frac{h}{\sqrt{2mE}}$</p> $\frac{\lambda_1}{\lambda_2} = \sqrt{\frac{E_2}{E_1}}$ <p>since $E_n \propto \frac{1}{n^2}$</p> <p>For $n = 2$ $E_2 = \frac{E_1}{4}$</p> $\therefore \frac{\lambda_1}{\lambda_2} = \sqrt{\frac{1}{4}} = \frac{1}{2}$ <p>[Award ½ mark if the student only writes $\lambda = \frac{h}{mv}$]</p> <p>Also accept any other correct alternative answer.</p>	1 ½ ½	2				
et-1, Q10 et-2, Q9 et-3, Q6	<table border="1" style="width: 100%;"> <tbody> <tr> <td style="width: 60%;">(a) Difference between Analog and Digital signal</td> <td style="width: 5%;">1</td> </tr> <tr> <td>(b) Any two uses of internet</td> <td>1</td> </tr> </tbody> </table>	(a) Difference between Analog and Digital signal	1	(b) Any two uses of internet	1		
(a) Difference between Analog and Digital signal	1						
(b) Any two uses of internet	1						

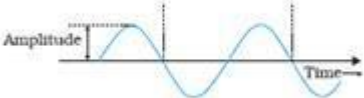

(a)	<table border="1"> <tr> <th>Analog signal (Any one of the two)</th> <th>Digital Signal (Any one of the two)</th> </tr> <tr> <td>It is single valued function of time or varies continuously with time</td> <td>These signals take only discrete set of values i.e. 0 or 1</td> </tr> <tr> <td>alternatively</td> <td>alternatively</td> </tr> <tr> <td></td> <td></td> </tr> </table>	Analog signal (Any one of the two)	Digital Signal (Any one of the two)	It is single valued function of time or varies continuously with time	These signals take only discrete set of values i.e. 0 or 1	alternatively	alternatively			1	2
	Analog signal (Any one of the two)	Digital Signal (Any one of the two)									
It is single valued function of time or varies continuously with time	These signals take only discrete set of values i.e. 0 or 1										
alternatively	alternatively										
											
(b) Uses of Internet : Any two (E mail, E- banking, chatting, file transfer, e-shopping, e-ticketing, surfing etc)	$\frac{1}{2} + \frac{1}{2}$										

Section - C

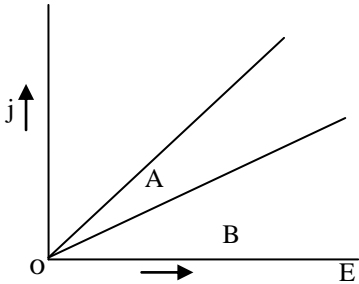
et-1, Q11 et-2, Q20 et-3, Q15	<table border="1"> <tr> <td>Formula</td> <td>$\frac{1}{2}$</td> </tr> <tr> <td>Graph</td> <td>1</td> </tr> <tr> <td>Information from the graph</td> <td></td> </tr> <tr> <td>Selecting the materials</td> <td>1</td> </tr> <tr> <td>Explanation for large current</td> <td>$\frac{1}{2}$</td> </tr> </table>	Formula	$\frac{1}{2}$	Graph	1	Information from the graph		Selecting the materials	1	Explanation for large current	$\frac{1}{2}$	$\frac{1}{2}$	3
	Formula	$\frac{1}{2}$											
Graph	1												
Information from the graph													
Selecting the materials	1												
Explanation for large current	$\frac{1}{2}$												
<p style="text-align: center;">$j = \sigma E$</p>  <p>Slope of the graph= conductivity (σ) Material with less slope (smaller conductivity) is used for making standard resistances and material with greater slope (higher conductivity) for making connecting wires</p> <p>We have $I = nAev_d$</p> <p>Although v_d is small but n (electron number density) is very large. Hence the current can be large.</p>	$\frac{1}{2}$	$\frac{1}{2}$											

et-1, Q12 et-2, Q21 et-3, Q16	Statement	$\frac{1}{2}$ mark	
	Derivation of magnetic field on axis	2 marks	
	Magnetic field at centre	$\frac{1}{2}$ mark	



Biot Savart's law

$$\vec{dB} \propto I \frac{d\vec{l} \times \vec{r}}{r^3}$$

$$\text{Or } \vec{dB} = \frac{\mu_0}{4\pi} I \frac{d\vec{l} \times \hat{r}}{r^2}$$

[Also accept if the student writes $dB \propto I$, $dB \propto dl$ and $dB \propto \frac{1}{r^2}$]

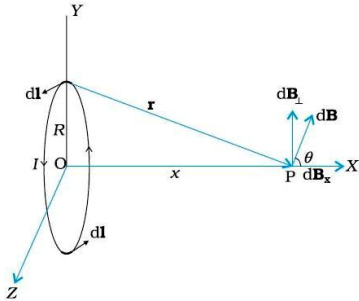

Derivation

The resultant magnetic field will be along the axis as the perpendicular (to the axis) components cancel out in pairs.

$$B = \int_0^{2\pi R} dB \cos \theta$$

$$= \int_0^{2\pi R} \frac{\mu_0}{4\pi} \frac{I dl}{(R^2+x^2)} \frac{R}{(R^2+x^2)^{1/2}}$$

$$= \frac{\mu_0 I}{4\pi} \frac{2\pi R^2}{(R^2+x^2)^{3/2}} = \frac{\mu_0 I R^2}{2(R^2+x^2)^{3/2}}$$

At centre, $x=0$

$$\therefore B_0 = \frac{\mu_0 I}{2R}$$

1/2

1/2

1/2

1/2

1/2

1/2

3

et-1, Q13
et-2, Q22
et-3, Q17

Polaroid	1
Transverse nature of light	1
Required Explanation	1

Polaroid consists of long chain molecules aligned in a particular direction
Transverse nature of light.

1

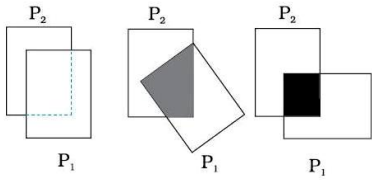

Alternatively

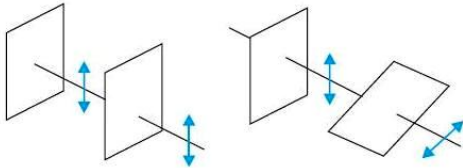

Explanation:

Unpolarised light incident on a polaroid, gets linearly polarized with electric vector oscillating along the pass axis of Polaroid.

It will pass out with same intensity from P₂, if pass axis of P₂ is parallel to that of P₁. On rotating P₂ intensity of light reduces to zero when their pass axes are perpendicular to each other showing transverse nature of light.

Explanation for intensity of light

Unpolarised light incident on a Polaroid, gets polarized and its intensity is reduced to half and it does not depend on the orientation of the Polaroid.

1/2

1/2

1/2

1/2

3

et-1, Q14
et-2, Q16
et-3, Q18

Fabrication of Zener Diode	1/2
Cause of high Electric field	1/2
Diagram for Zener Diode as Voltage Regulator	1
Working	1

Zener diode is fabricated by heavy doping of its p and n sections. Since doping is high, depletion layer becomes very thin. Hence, electric field ($= \frac{V}{d}$) becomes high even for a small reverse bias.

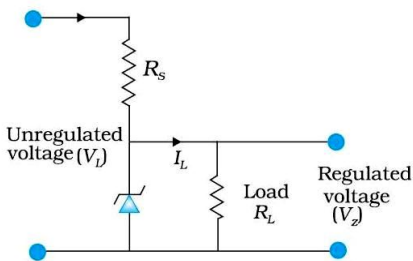

Working :

If input voltage increases/ decreases, current through Zener diode will also increase/ decreases. It increases/ decreases voltage drop across R_s without any

1/2

1/2

1

1

2

breakdown region giving the regulated output voltage.

OR

(a) Diagram	1/2
Formation of depletion region	1
Potential barrier	1/2
b) Effect on barrier potential	1

a)

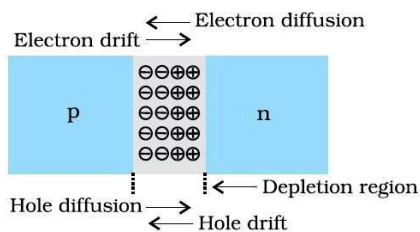

Explanation

Due to concentration gradient across p and n sides, holes from p diffuse into n section and leave behind ionized acceptor (negatively) ions which are immobile. As holes continue to diffuse from p to n, a layer of negative charge on p side of junction is formed. Similarly, the diffusion of electrons from n to p will form a positive charge space region on the n side.

The space charge region on either side of the junction which gets devoid of mobile charge carrier is known as the **depletion layer**.

The loss of electrons from n side and holes from p side cause a potential difference across the junction. This is known as the called barrier potential .

b) Barrier potential decreases in forward bias .

Barrier potential increases in reverse bias.

Effect in each case	1 1/2
Justification in each case	1 1/2

i) Anode current will increase with increase of intensity
More is intensity of light, more is the number of photons and hence more number of electrons are emitted

et-1, Q15
et-2, Q17
et-3, Q11

3

1/2

1

1/2

1/2

1/2

1/2

1/2

	Frequency of light affects the maximum K.E. of the emitted photoelectrons.	1/2	
	iii) Anode current will increase with anode potential More anode potential will accelerate the electrons more till it attains a saturation value and get them collected at the anode at a faster rate.	1/2 1/2	3

et-1, Q16 et-2, Q18 et-3, Q12	<table border="1"> <tr> <td>Active state</td> <td>1/2</td> </tr> <tr> <td>Circuit diagram</td> <td>1</td> </tr> <tr> <td>Working</td> <td>1/2</td> </tr> <tr> <td>Reasons in each case</td> <td>1</td> </tr> </table> <p><u>Active State :</u></p> <p>When the emitter base junction is forward biased and the base collector junction is reverse biased with $V_i > 0.6V$ or $V_i > 0.3V$. (Also accept any other correct answer)</p> <p><u>Diagram :</u></p> <p><u>Explanation :</u></p> <p>If V_i is +ve or -ve, changes in V_{BE} will produce changes in I_c and hence changes in V_{CE} which will appear in amplified form</p> <p><u>Base</u> is thin so that there are few majority carriers in it.</p> <p><u>Emitter</u> is heavily doped so that it supplies more number of majority charge carriers. (Note: Award 1 mark if the student writes the reason for any one case)</p>	Active state	1/2	Circuit diagram	1	Working	1/2	Reasons in each case	1	1/2 1/2 1/2 1/2 1 1/2 1/2 1/2	3
Active state	1/2										
Circuit diagram	1										
Working	1/2										
Reasons in each case	1										

et-1, Q17 et-2, Q19 et-3, Q13	<table border="1"> <tr> <td>Factors for need of modulation</td> <td>1 1/2</td> </tr> <tr> <td>Sketch of carrier wave, modulating wave and AM wave</td> <td>1 1/2</td> </tr> </table> <p><u>Need of Modulation:</u></p> <p>1. To have smaller height of antenna [$h \sim \frac{\lambda}{4}$]</p>	Factors for need of modulation	1 1/2	Sketch of carrier wave, modulating wave and AM wave	1 1/2	1/2	
Factors for need of modulation	1 1/2						
Sketch of carrier wave, modulating wave and AM wave	1 1/2						

2. So that more power is radiated by the antenna, $P \propto \frac{1}{\lambda^2}$

3. To avoid mixing up of signals from different transmissions.

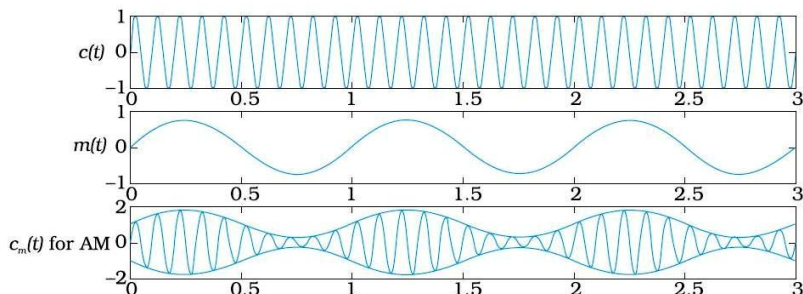

1/2

1/2

1/2

1/2

1/2

3

Set-1, Q18
Set-2, Q11
Set-3, Q14

Identification of circuit elements	1 1/2
Impedance value	1/2
Plot of circuit vs frequency	1/2
Significance of plot	1/2

Identification of elements

X- Resistor

Y- Inductor

Z- Capacitor

1/2

1/2

1/2

Impedence $Z=R$ Since $X_L = X_C$

(Also accept if the student writes $Z = \sqrt{R^2 + (X_L - X_C)^2} = R$

1/2

Plot of current vs frequency

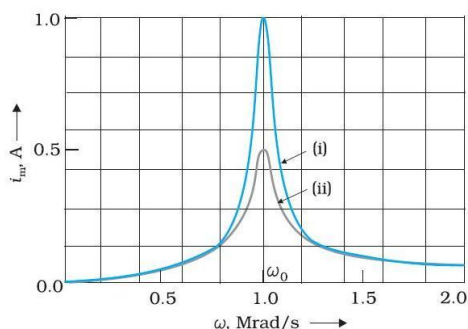

1/2

(Only one curve is expected)

Significance. at $\omega = \omega_0$ (resonance frequency) current is maximum



et-1, Q19 et-2, Q12 et-3, Q21	<table border="1" style="width: 100%; border-collapse: collapse;"> <tbody> <tr> <td style="padding: 5px;">Equation of β^+ decay</td> <td style="text-align: right; padding: 5px;">1</td> </tr> <tr> <td style="padding: 5px;">Identification</td> <td style="text-align: right; padding: 5px;">$\frac{1}{2}$</td> </tr> <tr> <td style="padding: 5px;">Calculation of mass defect</td> <td style="text-align: right; padding: 5px;">$\frac{1}{2}$</td> </tr> <tr> <td style="padding: 5px;">Calculation of Q value</td> <td style="text-align: right; padding: 5px;">1</td> </tr> </tbody> </table> <p style="margin-top: 10px;">Equation ${}^{11}_6C \rightarrow {}^{11}_5X + e^+ + \nu + Q$</p> <p>(Also accept if the student does not write ν or Q on the R.H.S.)</p> <p>X is an isobar</p> <p>Mass defect (Δm) = $m({}^{11}_6C) - m({}^{11}_5X)$</p> <p style="margin-left: 40px;">$= (11.011434 - 11.009305)u$</p> <p style="margin-left: 40px;">$= 0.002129 u$</p> <p>Q = $\Delta m \times 931.5 \text{ MeV}$</p> <p style="margin-left: 40px;">$= 0.002129 \times 931.5 \text{ MeV}$</p> <p style="margin-left: 40px;">$= 1.98 \text{ MeV}$</p>	Equation of β^+ decay	1	Identification	$\frac{1}{2}$	Calculation of mass defect	$\frac{1}{2}$	Calculation of Q value	1	<p>1</p> <p>$\frac{1}{2}$</p> <p>$\frac{1}{2}$</p> <p>$\frac{1}{2}$</p> <p>$\frac{1}{2}$</p> <p>3</p>	
Equation of β^+ decay	1										
Identification	$\frac{1}{2}$										
Calculation of mass defect	$\frac{1}{2}$										
Calculation of Q value	1										
et-1, Q20 et-2, Q13 et-3, Q22	<table border="1" style="width: 100%; border-collapse: collapse;"> <tbody> <tr> <td style="padding: 5px;">Calculation to find image formed by lens</td> <td style="text-align: right; padding: 5px;">$1\frac{1}{2}$</td> </tr> <tr> <td style="padding: 5px;">Nature of image</td> <td style="text-align: right; padding: 5px;">$\frac{1}{2}$</td> </tr> <tr> <td style="padding: 5px;">Distance of mirror from lens</td> <td style="text-align: right; padding: 5px;">1</td> </tr> </tbody> </table> <p style="margin-top: 10px;">For lens $\frac{1}{v} - \frac{1}{u} = \frac{1}{f}$</p> <p>$\frac{1}{v} - \frac{1}{-15} = \frac{1}{+10}$</p> <p>$\frac{1}{v} + \frac{1}{15} = \frac{1}{10}$</p> <p>$\therefore v = 30 \text{ cm}$</p> <p>Nature of image- real, magnified</p> <p>Final image formed will be at the object itself only if image formed by lens is at the position of centre of curvature of mirror</p> <p>$\therefore D = (30 + R)cm = (30 + 20)cm = 50 \text{ cm}$ (Distance of mirror from lens)</p>	Calculation to find image formed by lens	$1\frac{1}{2}$	Nature of image	$\frac{1}{2}$	Distance of mirror from lens	1	<p>$\frac{1}{2}$</p> <p>$\frac{1}{2}$</p> <p>$\frac{1}{2}$</p> <p>$\frac{1}{2}$</p> <p>$\frac{1}{2}$</p> <p>$\frac{1}{2}$</p> <p>3</p>			
Calculation to find image formed by lens	$1\frac{1}{2}$										
Nature of image	$\frac{1}{2}$										
Distance of mirror from lens	1										



Set-1, Q21 Set-2, Q14 Set-3, Q19	<table border="1" style="width: 100%;"> <tr> <td style="width: 80%;">Arranging in order</td> <td style="width: 20%; text-align: right;">1½</td> </tr> <tr> <td>Production of infrared waves</td> <td style="text-align: right;">½</td> </tr> <tr> <td>Role of infrared waves in Earth's warmth and physical therapy</td> <td style="text-align: right;">1</td> </tr> </table> <p>Gamma(γ) rays, X-rays, Microwaves, Radiowaves</p> <p>Infrared rays are produced by hot bodies / vibration of atoms and molecules</p> <p>Infrared rays: (i) Maintain Earth's warmth through green house effect</p> <p style="text-align: center;">(ii) Produce heat</p>	Arranging in order	1½	Production of infrared waves	½	Role of infrared waves in Earth's warmth and physical therapy	1	<p>1½</p> <p>½</p> <p>½</p> <p>½</p>	<p>3</p>		
Arranging in order	1½										
Production of infrared waves	½										
Role of infrared waves in Earth's warmth and physical therapy	1										
Set-1, Q22 Set-2, Q15 Set-3, Q20	<table border="1" style="width: 100%;"> <tr> <td style="width: 80%;">Process of charging capacitor</td> <td style="width: 20%; text-align: right;">1</td> </tr> <tr> <td>Effect of dielectric on</td> <td></td> </tr> <tr> <td>(i) Electric field and justification</td> <td style="text-align: right;">½+½</td> </tr> <tr> <td>(ii) Energy stored and justification</td> <td style="text-align: right;">½+½</td> </tr> </table> <p><u>Process of charging</u></p> <p>The electrons, from the plate of the capacitor, which is connected to the positive terminal of the battery, move towards the battery. The reverse happens at the other plate. Hence, the plates get positively and negatively charged respectively.</p> <p><u>Effect of dielectric</u></p> <p>(a) Electric fields decreases Justification</p> <p style="text-align: center;">Because initially $E_1 = \frac{\sigma}{\epsilon_0}$ and finally $E_2 = \frac{1}{K} \cdot \frac{\sigma}{\epsilon_0}$,</p> $E = \frac{E_1}{K}$ <p>(b) Energy stored increases</p> <p>New capacitance $C = \left(\frac{\epsilon_0 A}{2d}\right) k$</p> $= \frac{K}{2} C_o, \quad \therefore C < C_o$ <p>Initially Energy = $\frac{Q^2}{2C}$ and Energy = $\frac{Q^2}{C} \cdot \frac{2}{K}$ as $1 < K < 2$</p>	Process of charging capacitor	1	Effect of dielectric on		(i) Electric field and justification	½+½	(ii) Energy stored and justification	½+½	<p>½</p> <p>½</p> <p>½</p> <p>½</p> <p>½</p> <p>½</p>	<p>3</p>
Process of charging capacitor	1										
Effect of dielectric on											
(i) Electric field and justification	½+½										
(ii) Energy stored and justification	½+½										

Section – D

Set-1, Q23 Set-2, Q23 Set-3, Q23	<table border="1" style="width: 100%;"> <tr> <td style="width: 80%;">Necessity</td> <td style="width: 20%; text-align: right;">1</td> </tr> <tr> <td>Explanation; low power factor implies large power loss?</td> <td style="text-align: right;">1</td> </tr> <tr> <td>Two values each displayed by Ajit and his uncle</td> <td style="text-align: right;">1+1</td> </tr> </table>	Necessity	1	Explanation; low power factor implies large power loss?	1	Two values each displayed by Ajit and his uncle	1+1		
Necessity	1								
Explanation; low power factor implies large power loss?	1								
Two values each displayed by Ajit and his uncle	1+1								

<p>a) For the same power at high voltage, current in the transmission wires becomes smaller. \therefore power loss is less</p> <p>[Award ½ mark if the student just writes $P = I^2R$]</p> <p>b) If power factor is less, current in the cables is more so power loss is more [Alternately $P_{av} = E_v I_v \cos \theta$</p> <p>If $\cos \theta$ is less, I_v is more so power loss is more] (Award ½ mark if the student just writes $P = E_E I_v \cos \theta$)</p> <p>c) Values displayed By Ajit (Any two) – Social Awareness, understanding nature, concern for society By Uncle- Knowledgeable, professional honesty, concern for society. (Also accept other suitable values)</p>	<p>½ ½</p> <p>1</p> <p>½ +½ ½ +½</p>	<p>4</p>
--	--	----------

Section - E

<p>Set-1, Q24 Set-2, Q26 Set-3, Q25</p>	<table border="1" style="width: 100%;"> <tr> <td>Definition of self-inductance</td> <td style="text-align: right;">1</td> </tr> <tr> <td>Expression for energy stored</td> <td style="text-align: right;">2</td> </tr> <tr> <td>Direction of induced current</td> <td style="text-align: right;">½</td> </tr> <tr> <td>Duration of induced current</td> <td style="text-align: right;">½</td> </tr> <tr> <td>Graphs of magnetic flux and induced e.m.f</td> <td style="text-align: right;">1</td> </tr> </table>	Definition of self-inductance	1	Expression for energy stored	2	Direction of induced current	½	Duration of induced current	½	Graphs of magnetic flux and induced e.m.f	1	<p>1</p> <p>½</p> <p>½</p> <p>½</p>	<p>4</p>
Definition of self-inductance	1												
Expression for energy stored	2												
Direction of induced current	½												
Duration of induced current	½												
Graphs of magnetic flux and induced e.m.f	1												
<p>a) Self inductance of a coil is numerically equal to magnetic flux linked with the coil when unit current passes through it. $L = \frac{\phi}{I}$</p> <p>Alternately Self inductance of a coil is numerically equal to induced e.m.f. produced in it when rate of change of current is unity in it.</p> <p>Expression for energy Induced e.m.f. produced in coil, $\varepsilon = -L \frac{dI}{dt}$</p> <p>$\therefore$ work done by the source, $dw = +\varepsilon I dt = LI dI$</p> $W = \int_0^I LI dI = \frac{1}{2} LI^2$ <p>b) Direction of induced current – clockwise (MNOP) [A student can also show the direction in the diagram itself]</p> <p>Duration of induced current - 1s</p>	<p>1</p> <p>½</p> <p>½</p> <p>½ +½ ½</p> <p>½</p>	<p>4</p>											

Plot of graph

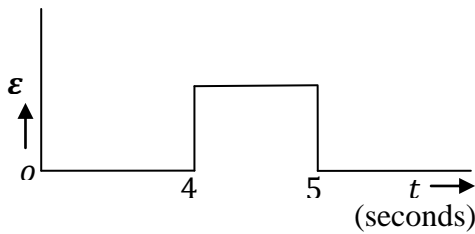
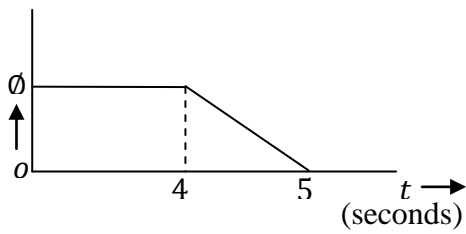

(Award this 1 mark even if the student draw the two graphs correctly without mentioning the values on the time axis)

OR

Plot of magnetic field lines	1
To show, $\vec{m} = I\vec{A}$	1
Expression for magnetic field due to finite solenoid and comparison with bar magnet	3

(a)

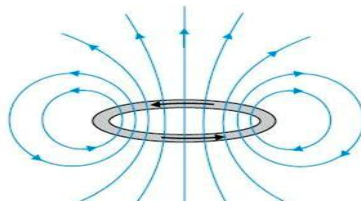

Magnetic field due to circular loop on its axis for far off points

$$B = \frac{\mu_0}{4\pi} \frac{2IA}{x^3}$$

Magnetic field due to bar magnet at an axial point

$$B = \frac{\mu_0}{4\pi} \frac{2m}{x^3}$$

By comparison $m = IA$

1/2

1/2

5

1

1/2

1/2

a) Magnetic field on the axis of a finite solenoid

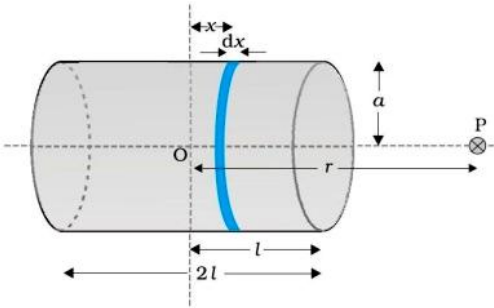

Magnetic field due to element dx at point P

$$dB = \frac{\mu_0 n dx l a^2}{2[(r-x)^2 + a^2]^{3/2}}$$

$$\therefore B = \int dB = \frac{\mu_0 I a^2 \times n}{2} \int_{-l}^{+l} \frac{dx}{[(r-x)^2 + a^2]^{3/2}}$$

For $r \gg a, (r \gg l)$

$$\therefore B = \frac{\mu_0 I a^2 n}{2 \times r^3} \int_{-l}^{+l} dx = \frac{\mu_0 n I}{2} \frac{2la^2}{r^3}$$

Magnetic moment of solenoid, $m = (n \times 2l)I(\pi a^2)$

$\therefore B = \frac{\mu_0}{4\pi} \frac{2m}{r^3}$ same as that of a bar magnet

Conditions for constructive and destructive interference	1½
Expression for fringe width	2
Fringe pattern in double slit related to diffraction pattern	½
Numerical	1

Diagram

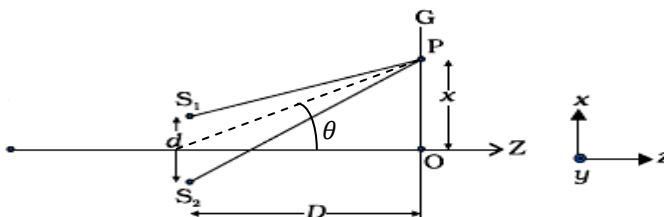

(a) Path difference (Δ) = $S_2P - S_1P = d \sin \theta = \frac{dx}{D}$

For constructive interference, $\Delta = n\lambda$ [$n = 0, 1, 2, \dots$]

Destructive interference, $\Delta = (2n - 1) \frac{\lambda}{2}$ [$n = 1, 2, \dots$]

For bright bands, $\Delta = n\lambda = \frac{x_n d}{D}$ or $x_n = \frac{n\lambda D}{d}$

For dark bands, $\Delta = (2n - 1) \frac{\lambda}{2} = \frac{x_n d}{D}$ or $x_n = (2n - 1) \frac{\lambda D}{2d}$

Fringe width $\beta = X_n - X_{n-1} = \frac{\lambda D}{d}$

b)

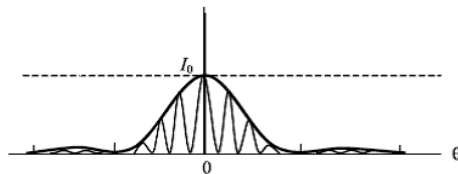

[Alternately

It is a broader diffraction peak in which there appears several fringes of smaller width due to double slit interference pattern]

(c) $10\beta =$ width of central maxima

$$10 \frac{D\lambda}{d} = 2 \frac{D\lambda}{a}$$

$$a = \frac{d}{5} = \frac{1}{5} \text{ mm} = 0.2 \text{ mm}$$

OR

Diagram for image formation	1/2
Derivation for combines focal length	1 1/2
Ray diagram through prism	1
Calculation of angle of incidence and angle of deviation	2

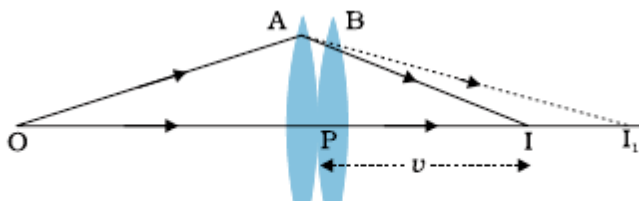

1/2

1/2

1/2

1/2

1/2

1/2

1/2

1/2

1/2

5

1/2

For First lens $\frac{1}{v_1} - \frac{1}{u} = \frac{1}{f_1}$ (i)

For Second lens $\frac{1}{v} - \frac{1}{v_1} = \frac{1}{f_2}$ (ii)

By adding i) and ii) $\frac{1}{v} - \frac{1}{u} = \frac{1}{f_1} + \frac{1}{f_2}$

Or $\frac{1}{f} = \frac{1}{f_1} + \frac{1}{f_2}$

b) Ray Diagram

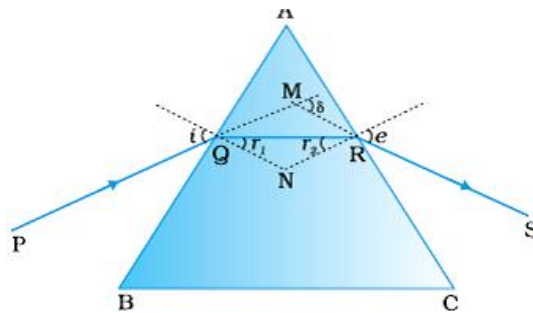

Given $A=60^\circ$, $\mu = \sqrt{3}$

It is minimum deviation position of prism,

$\therefore r = \frac{A}{2} = 30^\circ$

$\mu = \frac{\sin i}{\sin r}$

$\therefore \sqrt{3} \times \sin 30 = \sin i$

$\Rightarrow i = 60^\circ$

$\therefore e = 60^\circ$

$i + e = A + D$

$60 + 60 = 60 + D \therefore D = 60^\circ$

Alternately

$[i = \frac{A+D_m}{2} \therefore D_m = 60^\circ]$

Set-1, Q26	Expression for potential energy	2
Set-2, Q25	Numerical	3

- a) Expression for potential energy
- i) To bring charge q from ∞ to point (\vec{r})

1/2

1/2

1/2

1

1/2

1/2

1/2

1/2

5

ii) To bring charge q_2 from ∞ to point(\vec{r}_2)

$$\text{Work done} = W_2 = q_2 V(r_2) + \frac{1}{4\pi\epsilon_0} \cdot \frac{q_1 q_2}{r_{12}}$$

$$\therefore \text{Potential energy } U = W_1 + W_2 = q_1 V(r_1) + q_2 V(r_2) + \frac{K q_1 q_2}{r_{12}}$$

$$\begin{aligned} \text{b) } U_i &= \frac{1}{4\pi\epsilon_0} \left[\frac{Q \times 2Q}{l} + \frac{Q(-3)Q}{l} + \frac{2Q \times (-3)Q}{l} \right] \\ &= -\frac{1}{4\pi\epsilon_0} \frac{7Q^2}{l} \end{aligned}$$

$$\begin{aligned} U_f &= \frac{1}{4\pi\epsilon_0} \left[\frac{Q \times 2Q}{\frac{l}{2}} + \frac{Q(-3)Q}{\frac{l}{2}} + \frac{2Q \times (-3)Q}{\frac{l}{2}} \right] \\ &= -\frac{1}{4\pi\epsilon_0} \frac{14Q^2}{l} \end{aligned}$$

$$W = U_f - U_i = -\frac{1}{4\pi\epsilon_0} \frac{7Q^2}{l}$$

(If a student writes $U_i = \frac{1}{4\pi\epsilon_0} \left[\sum \sum \frac{q_i q_j}{r_{ij}} \right]$, award $\frac{1}{2}$ mark)

Or

Definition of electric flux	1
S.I. unit	$\frac{1}{2}$
State and explain Gauss's law	$1\frac{1}{2}$
Outward flux	1
Flux is independent of shape and size	1

Electric flux through a given area is defined as the number of electric field lines crossing normally through that area

[Alternately,

Electric flux is the surface integral of electric field over the surface

$$\Phi = \oint \vec{E} \cdot d\vec{s}]$$

S.I. unit - Nm^2C^{-1} or Vm

Gauss Law: Electric flux through a given closed surface is $\frac{1}{\epsilon_0}$ times the charge enclosed by the closed surface

[Alternatively: $\phi = \frac{q}{\epsilon_0}$]

$\frac{1}{2}$

1

1

1

1

5

1

$\frac{1}{2}$

$1\frac{1}{2}$



As the Electric field is radial and inversely proportional to the square of distance. Therefore, it is independent of shape and size. The number of electric field lines, crossing normally through a closed surface depends only on the charge enclosed by it.

1

5

